

CA167199

WHEELED COACH STOCK

170 x 95 x 72

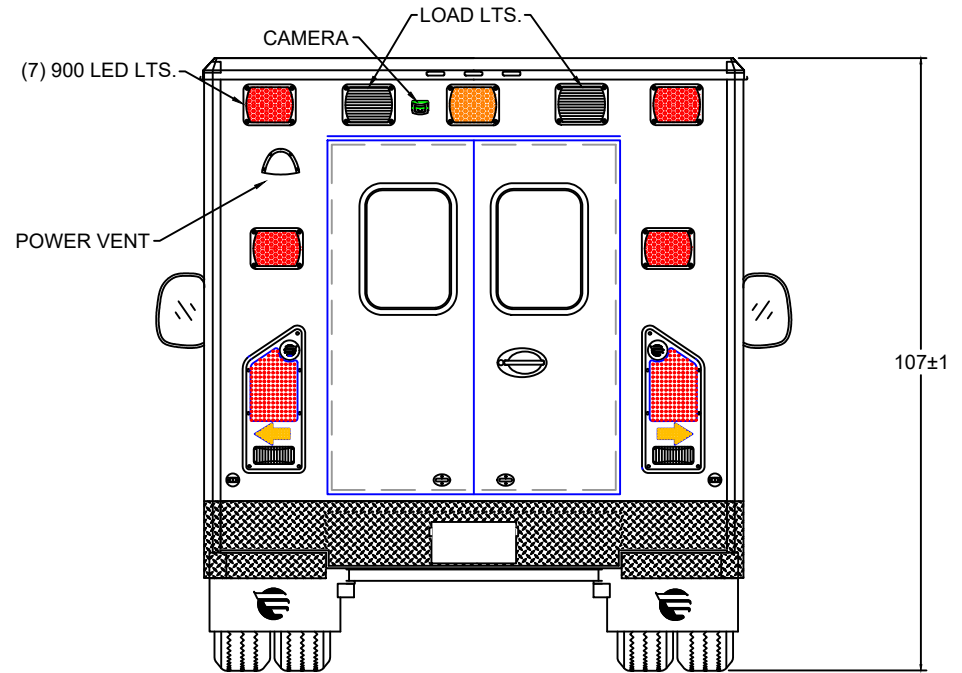
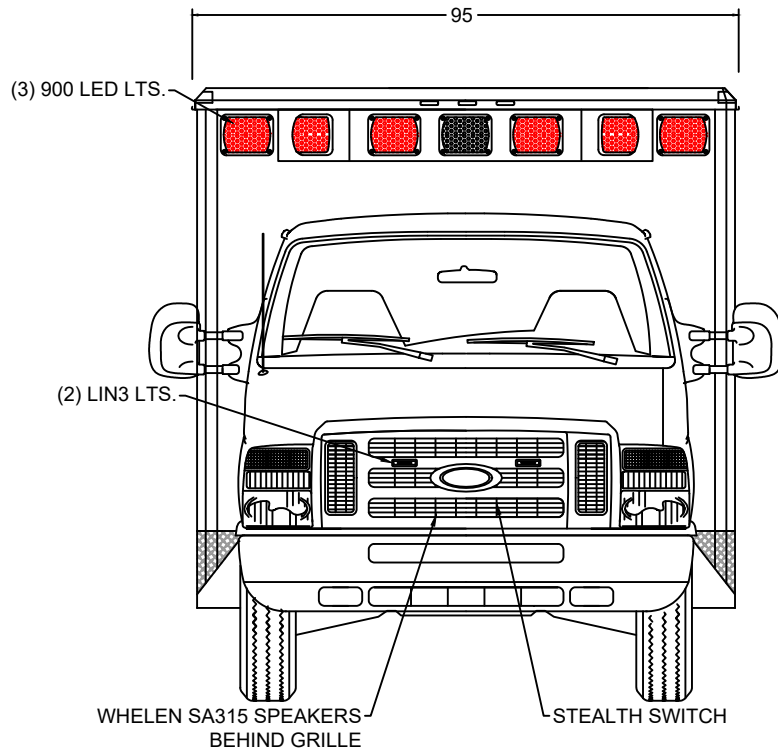

EXTERIOR COMPARTMENT DIMENSIONS IN INCHES

INTERIOR DIMENSIONS				PASS THRU		INTERIOR DIMENSIONS				JAMB OPENING	
COMPT.	HEIGHT	WIDTH	DEPTH	HEIGHT	WIDTH	COMPT.	HEIGHT	WIDTH	DEPTH	HEIGHT	WIDTH



TYPE 3 FORD  
FRONT / REAR  
EXTERIOR VIEWS

BE ADVISED THAT THESE ARE PRELIMINARY LAYOUTS INTENDED TO ILLUSTRATE DESIGN INTENT AND DIMENSIONS ARE FOR REFERENCE ONLY PRIOR TO FINAL ENGINEERING

DATE: 4/5/2023

SCALE

OWN BY: NP

DWG NO: 1 / 9

50" AISLE

CA167199

WHEELED COACH STOCK

170 x 95 x 72

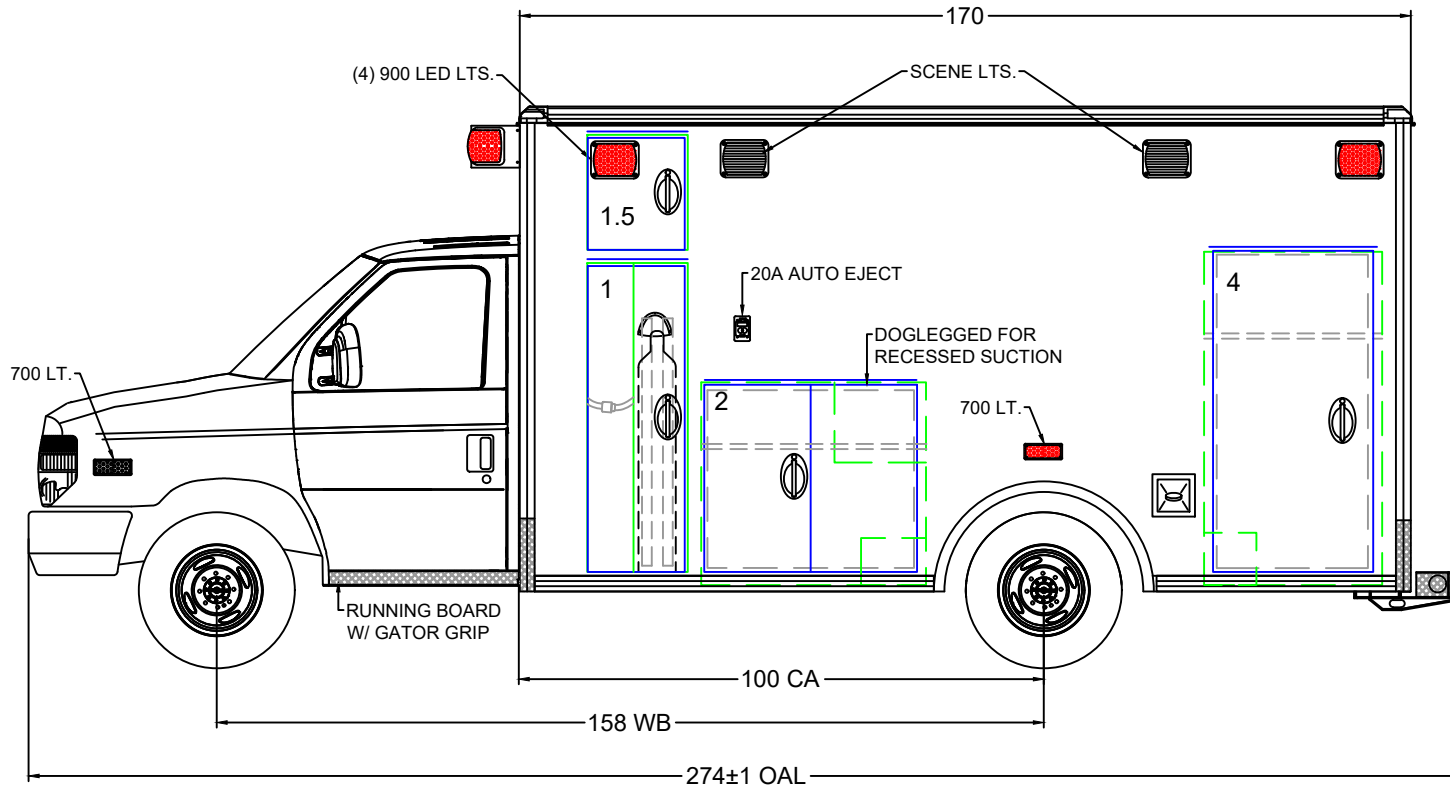

BE ADVISED THAT THESE ARE PRELIMINARY LAYOUTS INTENDED TO ILLUSTRATE DESIGN INTENT AND DIMENSIONS ARE FOR REFERENCE ONLY PRIOR TO FINAL ENGINEERING

EXTERIOR COMPARTMENT DIMENSIONS IN INCHES													
INTERIOR DIMENSIONS				JAMB OPENING		INTERIOR DIMENSIONS				JAMB OPENING			
COMPT.	HEIGHT	WIDTH	DEPTH	HEIGHT	WIDTH	COMPT.	HEIGHT	WIDTH	DEPTH	HEIGHT	WIDTH		
4	61.50	34.00	17.00	58.25	30.50							TYPE 3 FORD LEFT EXT. VIEW	
2	38.75	42.50	17.00	35.75	40.25								
1	59.00	19.00	21.75/17.00	58.50	18.50								
1.5	22.00	19.00	17.00	21.50	18.50								
50" AISLE												DATE 4/5/2023 DRAWN BY NP	SCALE DWG NO 2 / 9

CA167199

WHEELED COACH STOCK

170 x 95 x 72

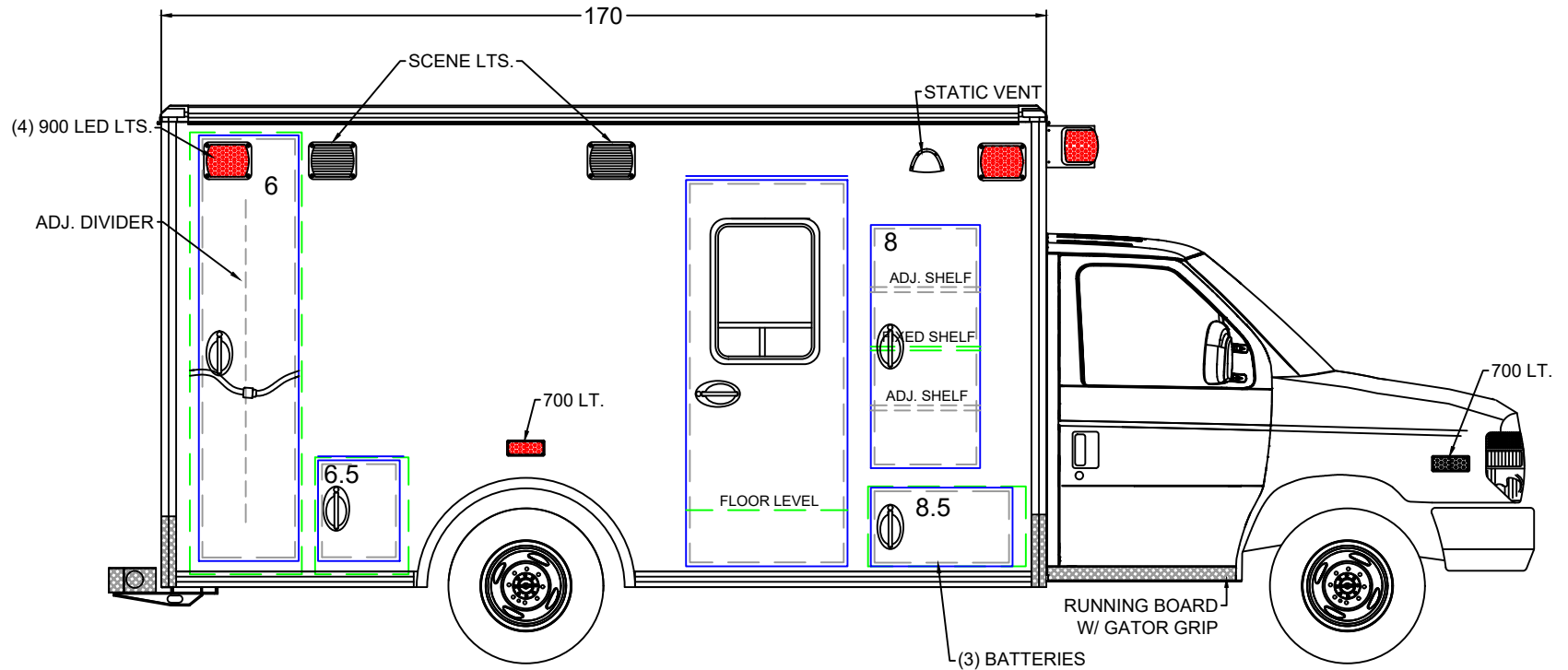

BE ADVISED THAT THESE ARE PRELIMINARY LAYOUTS INTENDED TO ILLUSTRATE DESIGN INTENT AND DIMENSIONS ARE FOR REFERENCE ONLY PRIOR TO FINAL ENGINEERING

EXTERIOR COMPARTMENT DIMENSIONS IN INCHES

INTERIOR DIMENSIONS				JAMB OPENING		INTERIOR DIMENSIONS				JAMB OPENING	
COMPT.	HEIGHT	WIDTH	DEPTH	HEIGHT	WIDTH	COMPT.	HEIGHT	WIDTH	DEPTH	HEIGHT	WIDTH
8					21.00						
8.5	15.25	30.25	19.00	15.00	27.25						
6.5	22.50	18.00	15.50	19.25	15.50						
6	85.00	21.50	18.25	81.75	19.00						



TYPE 3 FORD  
RIGHT EXT. VIEW

DATE 4/5/2023

SCALE

DRAWN BY NP

DWG NO 3 / 9

50" AISLE

CA167199

WHEELED COACH STOCK

170 x 95 x 72

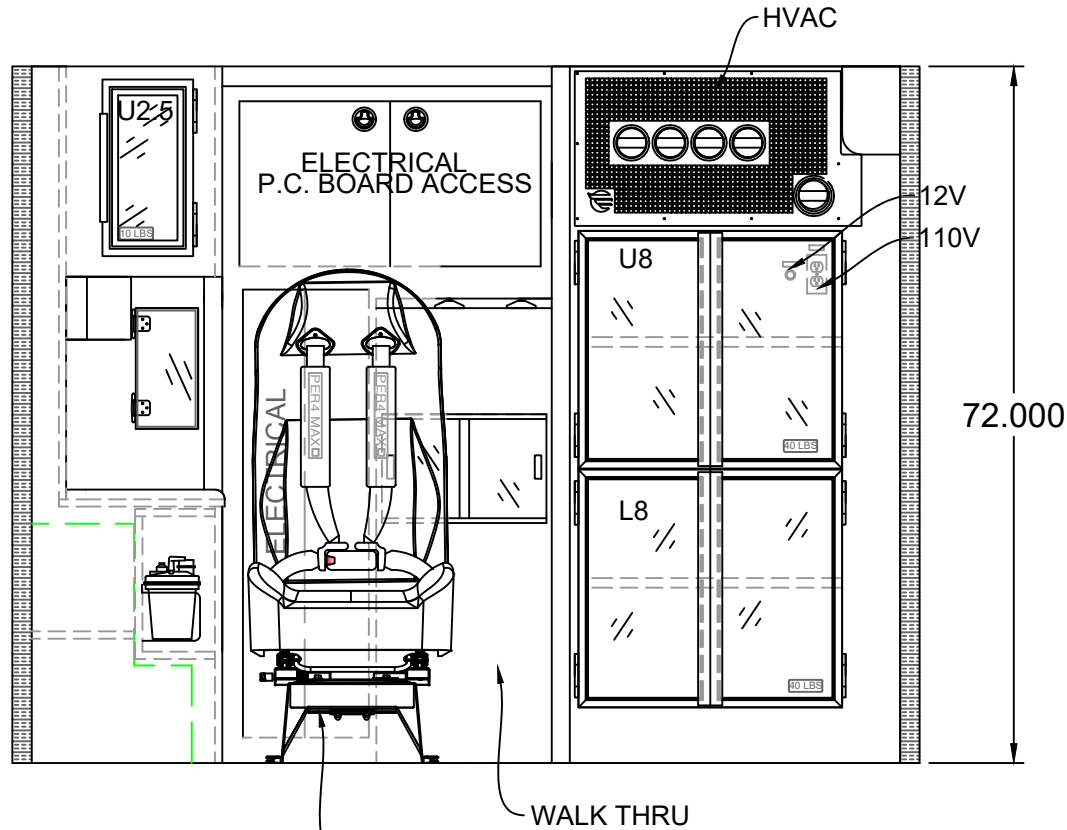

BE ADVISED THAT THESE ARE PRELIMINARY LAYOUTS INTENDED TO ILLUSTRATE DESIGN INTENT AND DIMENSIONS ARE FOR REFERENCE ONLY PRIOR TO FINAL ENGINEERING

ATTENDANT SEAT ON SWIVEL BASE

CABINET WEIGHT RATINGS:  
 NON-RESTOCKING = 40 LBS.  
 RESTOCKING = 30 LBS.

INTERIOR CABINET DIMENSIONS IN INCHES

CABINET	HEIGHT	WIDTH	DEPTH	CABINET	HEIGHT	WIDTH	DEPTH
U8	24.50	33.50	25.75				
L8	24.50	33.50	25.75				



TYPE 3 FORD  
 BULKHEAD INTERIOR

DATE 4/5/2023

SCALE

DRAWN BY NP

DWG NO 4 / 9

50" AISLE

CA167199

WHEELED COACH STOCK

170 x 95 x 72

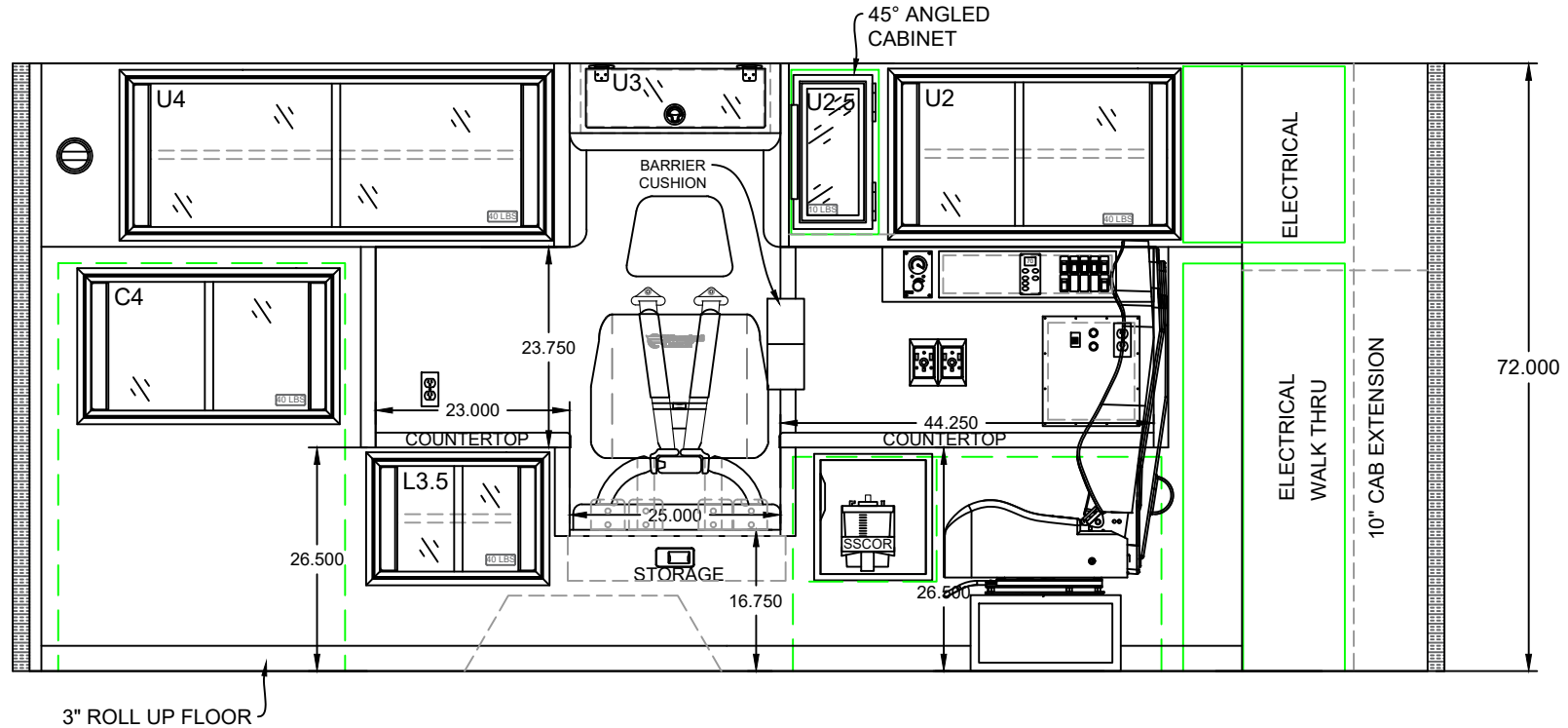

INTERIOR CABINET DIMENSIONS IN INCHES

CABINET	HEIGHT	WIDTH	DEPTH		CABINET	HEIGHT	WIDTH	DEPTH	
C4	17.00	29.50	IS/OS		CPR SEAT	4.50	23.50	17.50	
U4	18.75	49.75	17.50		U3	5.00	21.00	4.50	
L3.5	14.25	20.25	17.50						
U2.5	19.50	12.00	15.25						
U2	18.75	33.25	15.25						



TYPE 3 FORD

LEFT INTERIOR

DATE:	4/5/2023	SCALE:	
DWN BY:	NP	DWG NO:	5 / 9

50" AISLE

CABINET WEIGHT RATINGS:  
NON-RESTOCKING = 40 LBS.  
RESTOCKING = 30 LBS.

BE ADVISED THAT THESE ARE PRELIMINARY LAYOUTS INTENDED TO ILLUSTRATE DESIGN INTENT AND DIMENSIONS ARE FOR REFERENCE ONLY PRIOR TO FINAL ENGINEERING

CA167199

WHEELED COACH STOCK

170 x 95 x 72

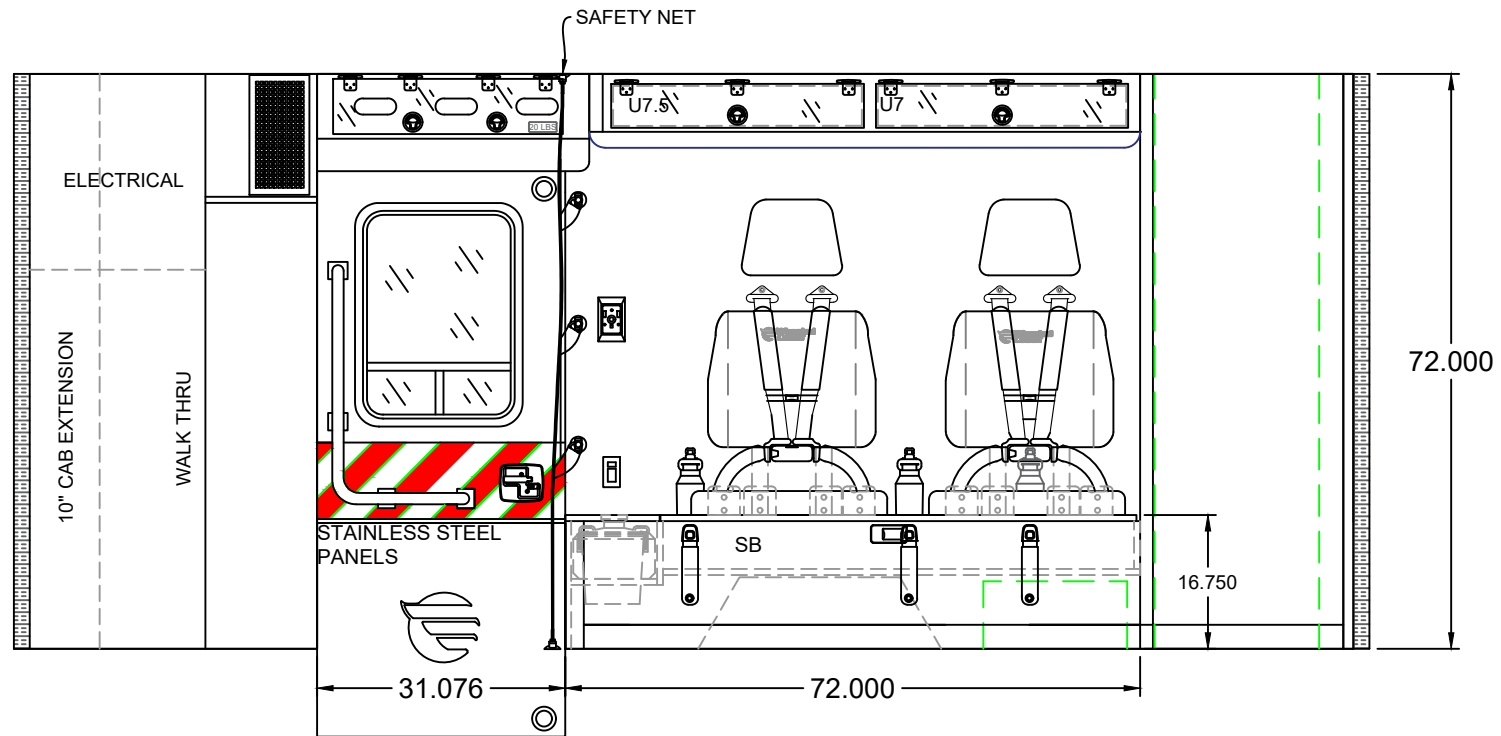

INTERIOR CABINET DIMENSIONS IN INCHES



TYPE 3 FORD  
RIGHT INTERIOR

DATE: 4/5/2023

SCALE

DWN BY

NP

DWG NO

6 / 9

COMPT.	HEIGHT	WIDTH	DEPTH		COMPT.	HEIGHT	WIDTH	DEPTH	
U7.5/U7	5.00	31.25	7.00						
SB	6.00	59.00	16.75						

50" AISLE

CABINET WEIGHT RATINGS:  
NON-RESTOCKING = 40 LBS.  
RESTOCKING = 30 LBS.

BE ADVISED THAT THESE ARE PRELIMINARY LAYOUTS INTENDED TO ILLUSTRATE DESIGN INTENT AND DIMENSIONS ARE FOR REFERENCE ONLY PRIOR TO FINAL ENGINEERING

CA167199

WHEELED COACH STOCK

170 x 95 x 72

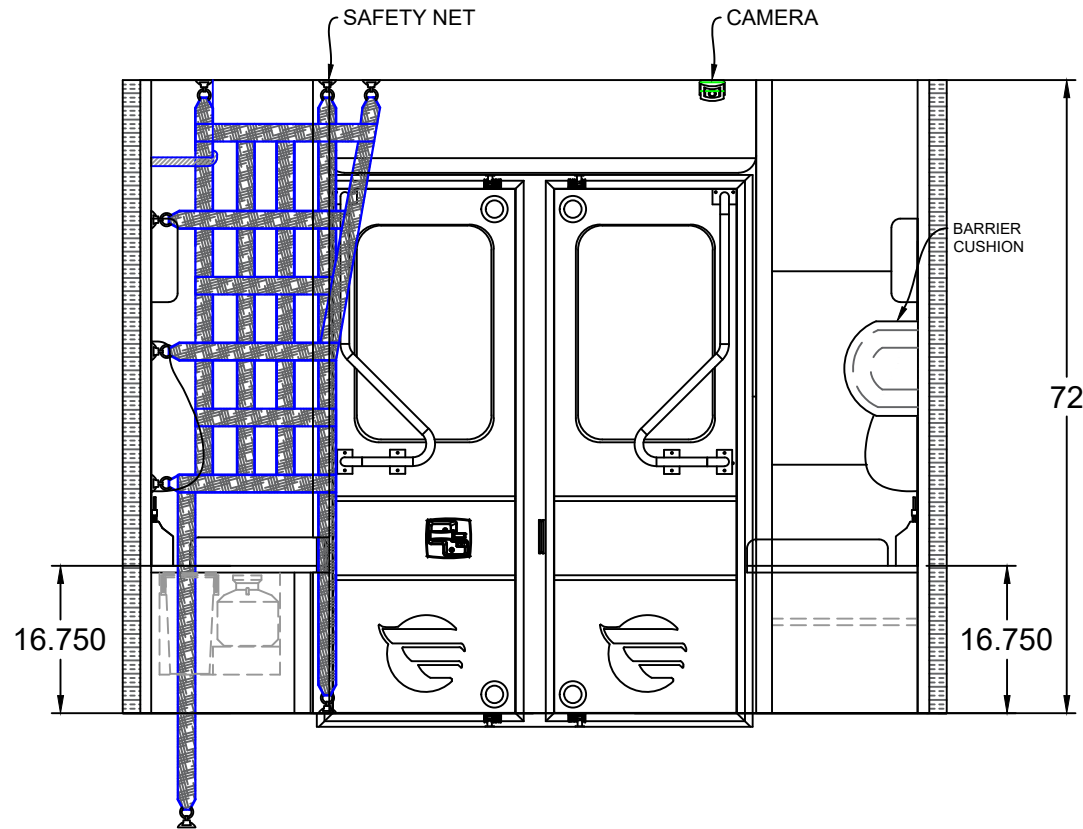

INTERIOR CABINET DIMENSIONS IN INCHES



TYPE 3 FORD

REAR BULKHEAD INTERIOR

DATE: 4/5/2023

SCALE

DWN BY

NP

DWG NO

7 / 9

50" AISLE

CABINET WEIGHT RATINGS:  
NON-RESTOCKING = 40 LBS.  
RESTOCKING = 30 LBS.

BE ADVISED THAT THESE ARE PRELIMINARY LAYOUTS INTENDED TO ILLUSTRATE DESIGN INTENT AND DIMENSIONS ARE FOR REFERENCE ONLY PRIOR TO FINAL ENGINEERING

CA167199

WHEELED COACH STOCK

170 x 95 x 72

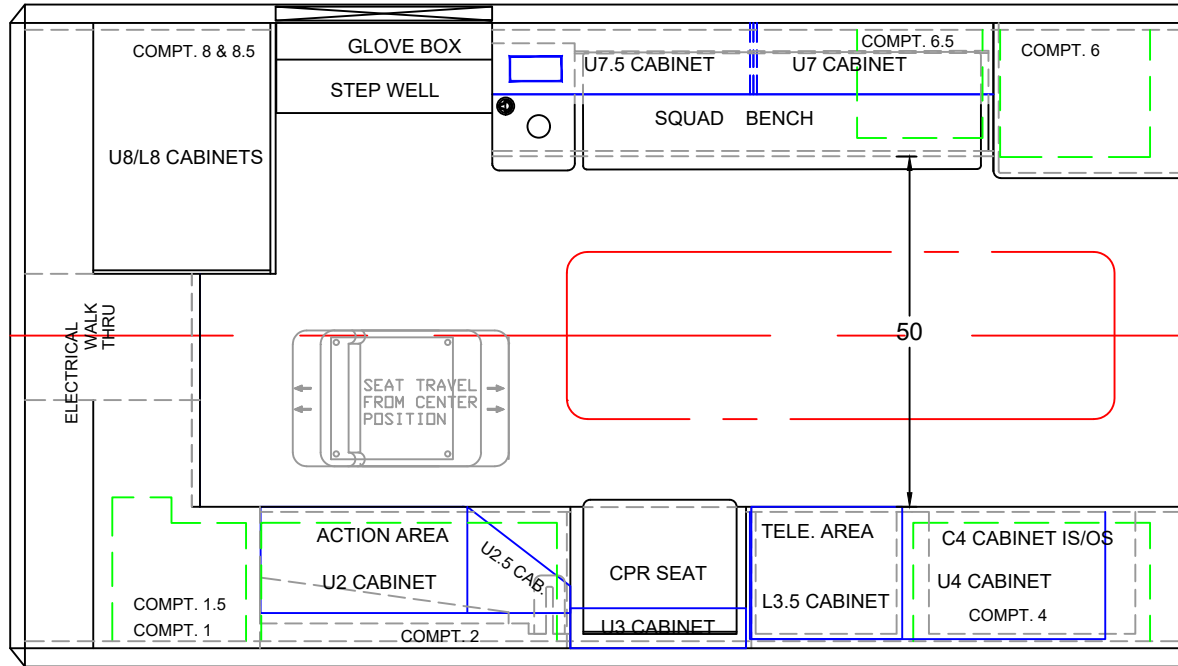

BE ADVISED THAT THESE ARE PRELIMINARY LAYOUTS INTENDED TO ILLUSTRATE DESIGN INTENT AND DIMENSIONS ARE FOR REFERENCE ONLY PRIOR TO FINAL ENGINEERING

CABINET WEIGHT RATINGS:  
NON-RESTOCKING = 40 LBS.  
RESTOCKING = 30 LBS.

50" AISLE

INTERIOR CABINET DIMENSIONS IN INCHES

CABINET	HEIGHT	WIDTH	DEPTH	CABINET	HEIGHT	WIDTH	DEPTH



TYPE 3 FORD  
FLOOR PLAN

DATE: 4/5/2023 SCALE:  
DWN BY: NP DWG NO: 8 / 9



CA167199

WHEELED COACH STOCK

170 x 95 x 72

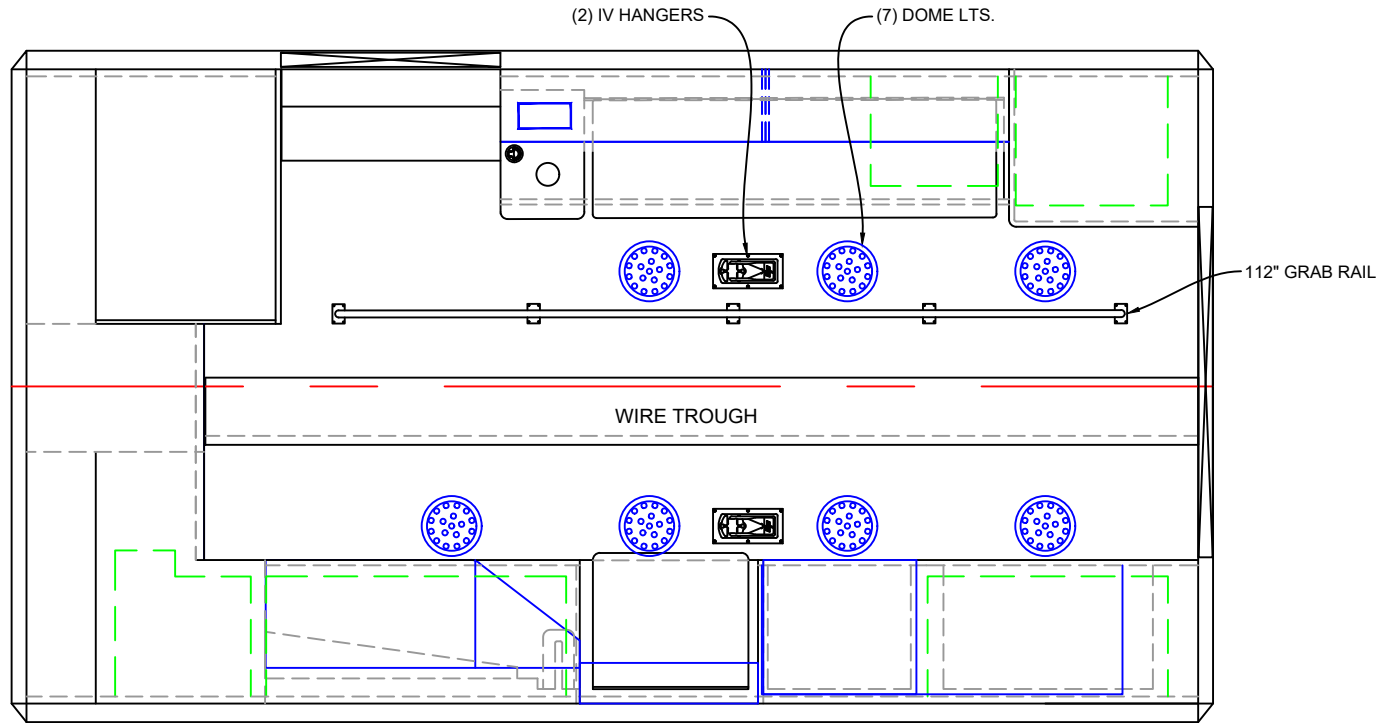

BE ADVISED THAT THESE ARE PRELIMINARY LAYOUTS INTENDED TO ILLUSTRATE DESIGN INTENT AND DIMENSIONS ARE FOR REFERENCE ONLY PRIOR TO FINAL ENGINEERING

CABINET WEIGHT RATINGS:  
NON-RESTOCKING = 40 LBS.  
RESTOCKING = 30 LBS.

50" AISLE

INTERIOR CABINET DIMENSIONS IN INCHES

CABINET	HEIGHT	WIDTH	DEPTH	CABINET	HEIGHT	WIDTH	DEPTH



TYPE 3 FORD

LINER

DATE: 4/5/2023

SCALE

DWN BY NP

DWG NO 9 / 9